



TEMPERATURE CONTROL  
FOR **TODAY & TOMORROW**



## SRK63ZR-W / SRC63ZR-W

Capacitate nominala de racire: **6.3 KW**



### Poze unitate interna si unitate externa



### Specificatii

Unitate internă			SRK63ZR-W
Unitate externă			SRC63ZR-W
Sursă de alimentare			Monofazic, 220 - 240, 50Hz
Capacitate nominală de răcire (Min~Max)		kW	6.3 (1.2~7.4)
Capacitate nominală de încălzire (Min~Max)		kW	7.1 (0.8~9.3)
Consum de energie	Răcire/Încălzire	kW	1.63 / 1.64
EER/COP	Răcire/Încălzire		3.87 / 4.33



## TEMPERATURE CONTROL FOR TODAY & TOMORROW



Amperaj maxim			A	14.5
Nivel putere sonoră	U.I.	Răcire/Încălzire	dB(A)	56 / 58
	U.E.	Răcire/Încălzire		64 / 65
Nivel presiune sonoră	U.I.	Răcire (Hi/Me/Lo/Ulo)		44 / 39 / 35 / 25
		Încălzire (Hi/Me/Lo/Ulo)		44 / 38 / 34 / 28
	U.E.	Răcire/Încălzire		54 / 54
Flux de aer	U.I.	Răcire (Hi/Me/Lo/Ulo)	m <sup>3</sup> /min	20.5 / 18.1 / 15.7 / 10.4
		Încălzire (Hi/Me/Lo/Ulo)		22.5 / 19.0 / 16.5 / 13.1
	U.E.	Răcire/Încălzire		41.5 / 41.5
Dimensiuni exterioare	U.I.	Înălțime / Lățime /	mm	339 x 1197 x 262
	U.E.	Adâncime		640 x 800(+71) x 290
Greutate netă	U.I. / U.E.		kg	15.5 / 45.0
Refrigerant		Tip/GWP		R32 / 675
Refrigerant		Încărcare		kg/TCO <sub>2</sub> Eq
Dimensiuni țevă refrigerant		Lichid/Gaz		mm/ø
Lungime țevă refrigerant (o direcție)			m	Max. 30
Diferență de nivel suportată		Unitate externă este mai sus/mai jos		m
Interval de funcționare - temperatură exterioară		Răcire		°C

**Datorită politicii de continuă îmbunătățire a produselor, ne rezervăm dreptul de a modifica specificațiile tehnice fără nicio notificare prealabilă.**



## TEMPERATURE CONTROL FOR TODAY & TOMORROW



Încălzire	-15~24	
Filtre		Filtru Antialergeni x1, Filtru lavabil fotocatalitic și dezodorizant x1
Clasa Energetică (Răcire/Încălzire)		A++/A++
SEER		8.10
SCOP (Climat temperat)		4.70
Pdesign (răcire/încălzire(@-10°C))	kW	6.30/5.40
Consumul anual de electricitate (răcire/încălzire)	kWh/a	273/1608
Performanța pe modul încălzire		Climat temperat

## Schema tehnica

---

**Datorită politicii de continuă îmbunătățire a produselor, ne rezervăm dreptul de a modifica specificațiile tehnice fără nicio notificare prealabilă.**



# TEMPERATURE CONTROL FOR TODAY & TOMORROW



**SRC20ZSX-W,-S SRC25ZSX-W,-S SRC35ZSX-W,-S**  
**SRC40ZSX-W,-S SRC50ZSX-W,-S SRC60ZSX-W,-S SRC63ZR-W,-S**

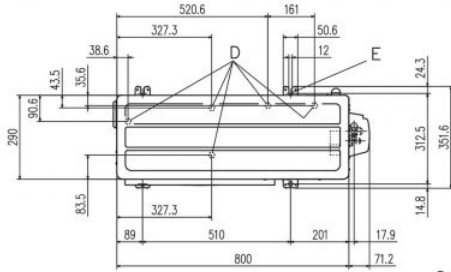

Symbol	Content
A	Service valve connection (gas side) 20.25.35 φ9.52(3/8") (Flare) 40.50.60.63 φ12.7(1/2") (Flare)
B	Service valve connection (liquid side) φ6.35 (1/4") (Flare)
C	Pipe/cable draw-out hole
D	Drain discharge hole φ20x5places
E	Anchor bolt hole M10x4places

Dimensions	Minimum installation space			
	I	II	III	IV
L1	Open	280	280	180
L2	100	75	Open	Open
L3	100	80	80	80
L4	250	Open	250	Open

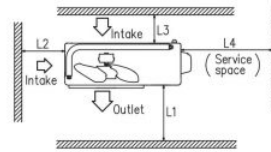
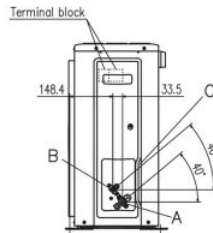
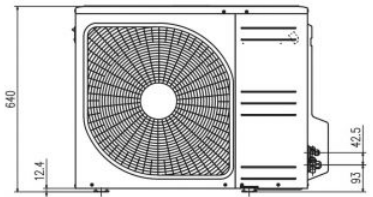

**SRK63ZR-W SRK71ZR-W SRK80ZR-W**  
**SRK63ZR-S SRK71ZR-S SRK80ZR-S SRK100ZR-S**

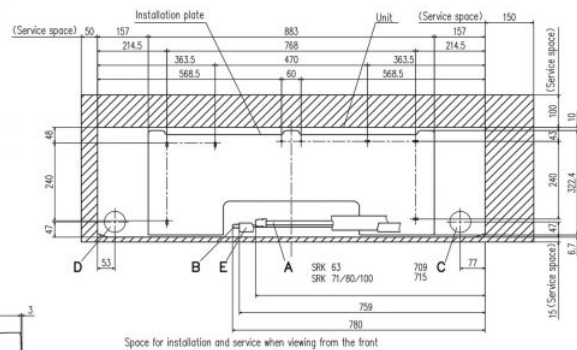
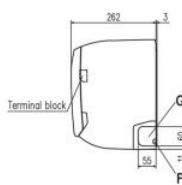
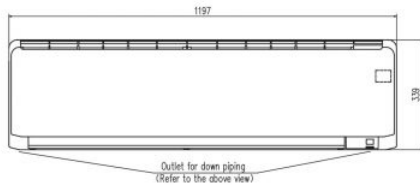
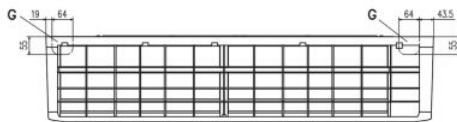

Symbol	Content
A	Gas piping SRK 63 φ12.7 (1/2") (Flare) SRK 71,80/100 φ15.88(5/8") (Flare)
B	Liquid piping SRK 63,71,80 φ6.35 (1/4") (Flare) SRK 100 φ9.52 (3/8") (Flare)
C	Hole on wall for right rear piping (φ65)
B	Hole on wall for left rear piping (φ65)
E	Drain hose φ16
F	Outlet for wiring (on both side)
G	Outlet for piping (on both side)

**Datorită politicii de continuă îmbunătățire a produselor, ne rezervăm dreptul de a modifica specificațiile tehnice fără nicio notificare prealabilă.**